

Mystic 64

Series : **Authentik Signature**

Nominal dimensions: **63.5" x 32.5" x 22" [161.3 cm x 82.6 cm x 55.9 cm]**

Seats : **2**

Product code: **MY64**

Draft revision : **2025022808040**

Lumbar support : yes Arm rests : no Undermount : no Low-profile available : no

Draft and specs

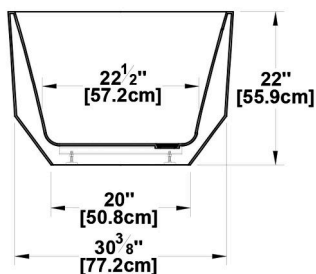
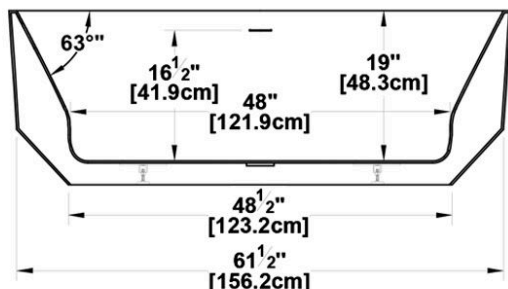
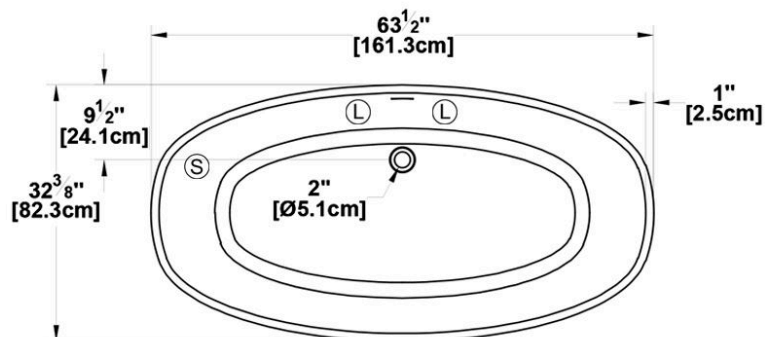

Specifications
Capacity: 63 IMP Gal. / 82.1 US Gal. / 286.4 liters
AeroMassage™: 44 Easy Clean™ air jets
Super AeroMassage™: unavailable
Characteristics: One-piece freestanding bath

Remarks
All measures have a precision of ± 1/4" (0,63cm)
If a measure is present on one side only, part is symmetrical
*internal dimensions taken at 4" (10cm) from bath bottom
*capacity is measured by filling the bath to 1-1/2" under the overflow





Available models
Soaker <input checked="" type="checkbox"/>
AeroMassage™ <input checked="" type="checkbox"/>
Super AeroMassage™ <input type="checkbox"/>

Available recommended options
Front skirt:
Recommended drain: Incl. INF101 (White finish)
Tile flanges: unavailable
Floating remote control: included if ordered with system
Linear overflow: Integrated



Additional(s) note(s)

Handmade product, edge width may be uneven and vary. The overflow is factory installed, the drain is included but not installed. When ordered with AeroMassage, blower must be remote mounted. If system, delivered with keypad not installed and remote control is included.

Legend	
 Blower air entry	 Chromatherapy light
 Grab bar	 Keypad
 Recommended faucets drilling location*	Deck cut-out line - - - - -

*It is possible to install the faucets elsewhere on the product. The installer must verify that there are no piping or wires before drilling.

IMPORTANT NOTE: Specifications, dimensions and models are subject to change.

Visit our website <http://www.oceania-attitude.com> to access up-to-date dimensions and information. In all cases, information on the website is the most up-to-date.

Head office

591, avenue des Entreprises
Theftord Mines, Quebec
CANADA G6H 4B2

Contact numbers

Phone : 1-877-332-4224
Fax : 1-866-460-4334

Internet

Web : <http://www.oceania-attitude.com>
Email : info@bainsoceania.com